



METALLOUMIN *Greece*

PHOTOVOLTAIC SUPPORT

Aluminium Mounting Structures for Photovoltaic Panels

all types of photovoltaic installations



industrial roof

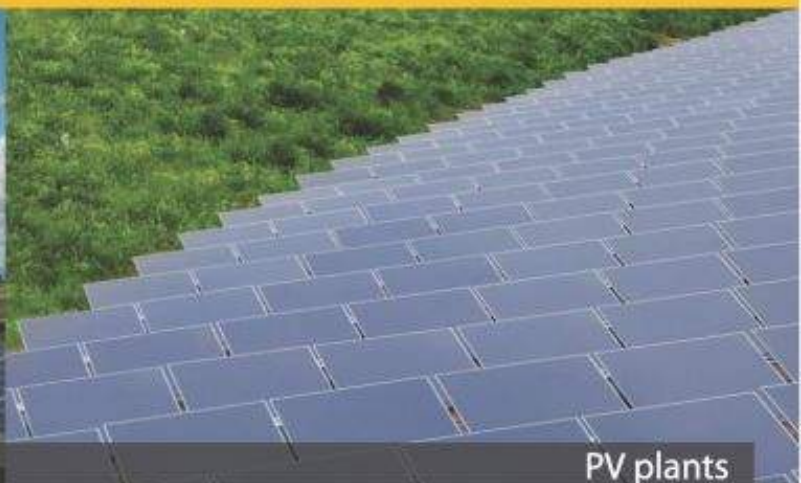

PV plants



flat roof



roof with tiles



METALOUMIN Greece

PHOTOVOLTAIC SUPPORT

MOUNTING SYSTEMS FOR FLAT ROOFS

(DRILLED OR BALLASTED)



The innovative mounting systems for photovoltaic installations have been designed, developed and produced by METALOUMIN S.A. and apply to flat roof installations

Advantages of the system

- Easy and quick assembly
- Vertical in-house production beginning with aluminium as raw material and resulting in final ready-to-be-installed product
- Unbeatable combination of robustness and price
- Production process certified with EN ISO 9001, TUV CERT Austria and EN ISO 140001 standards
- High quality INOX accessories

PREASSEMBLED MOUNTING SYSTEM WITH 1 PANEL IN HEIGHT PORTRAIT LAYOUT

Fixed mounting system with inclination on demand.

Alternatively adjustable mounting system is provided (inclination 25° and 30° or to customers requirements).

The structure has been studied for wind speed up to 33m/s, 2m height for area II (extra urban zone), 5m height for area III (industrial zone) and 10m height for area IV (urban).

Fastening torque: 13Nm for clamp, 35Nm M10 bolt, 25Nm T-bolt.

M-FR-301P



The mounting of the structure is enabled with the use of 2 anchors M10 per triangle. Chemical anchors are recommended.

MOUNTING SYSTEM WITH 2 PANELS IN HEIGHT PORTRAIT LAYOUT

M-FR-532P

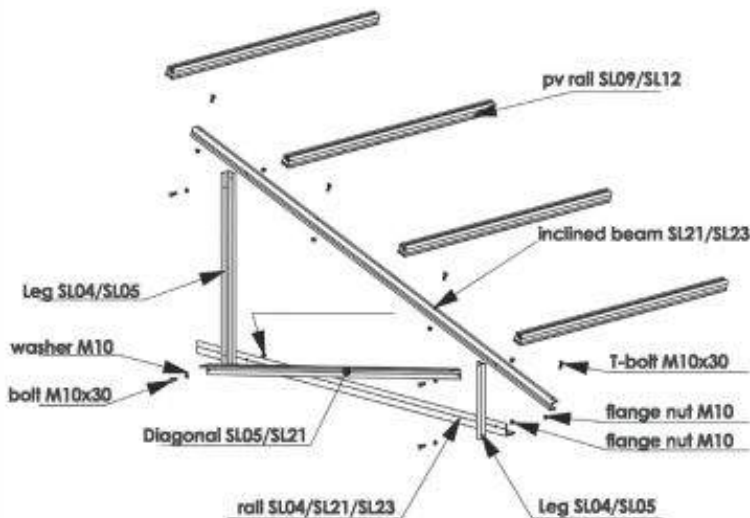

3 anchors M10 per triangle-ballasts

M-FR-502P

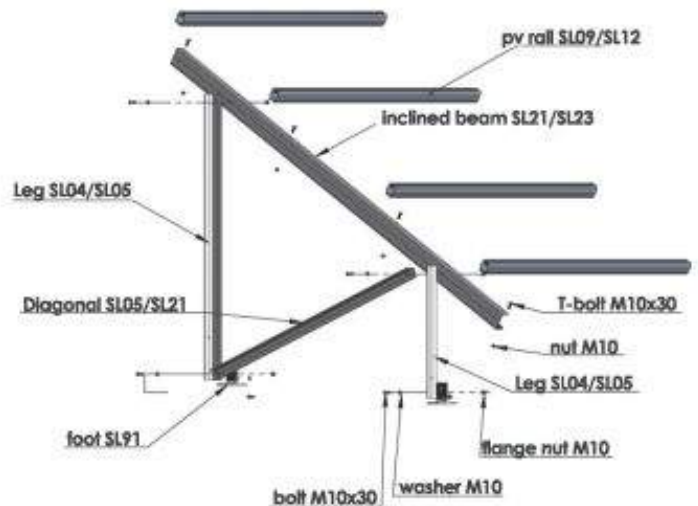

The mounting of the structure is enabled with the use of 2 anchors M10 per leg. Chemical anchors are recommended

SPECIAL CONSTRUCTIONS FOR MOUNTING SYSTEM OF:

2-6 PANELS IN PORTRAIT LAYOUT AND

-> M-FR-502~6P

1-7 PANELS IN LANDSCAPE LAYOUT

-> M-FR-501~7L

Steps for the installation of preassembled triangle with 1 panel in height, portrait layout

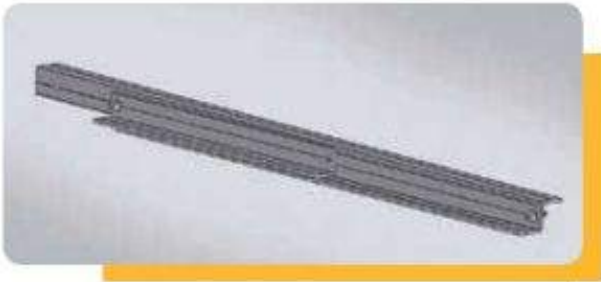

Step 1

Initial packing of the preassembled triangle

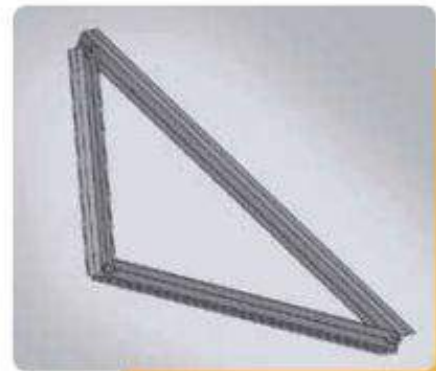

Step 2

Raise the inclined and place bolt, washer and nut
In case of a 25° inclination change the position of the upper bolt

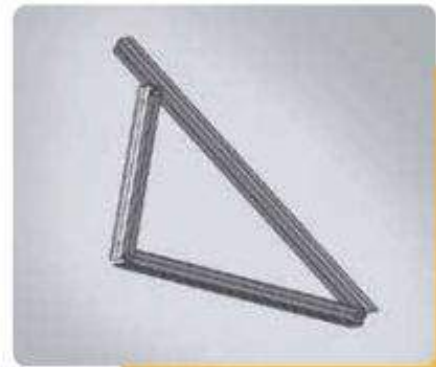

Step 3

Place the triangles in their right distances and anchor them to the floor

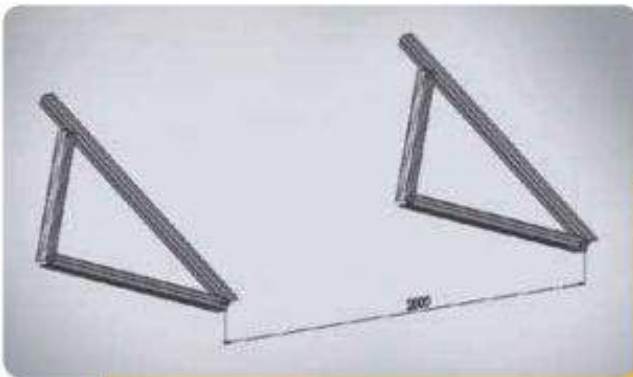

The same process applies for the preassembled triangle with 1 panel in height, landscape - layout



Completed assembly



M-FR-350

East - West system with ballasts

ADVANTAGES

- Self-mounted system
- No drilling or intervention in the roof
- Full coverage of the available surface
- Easy and simple installation

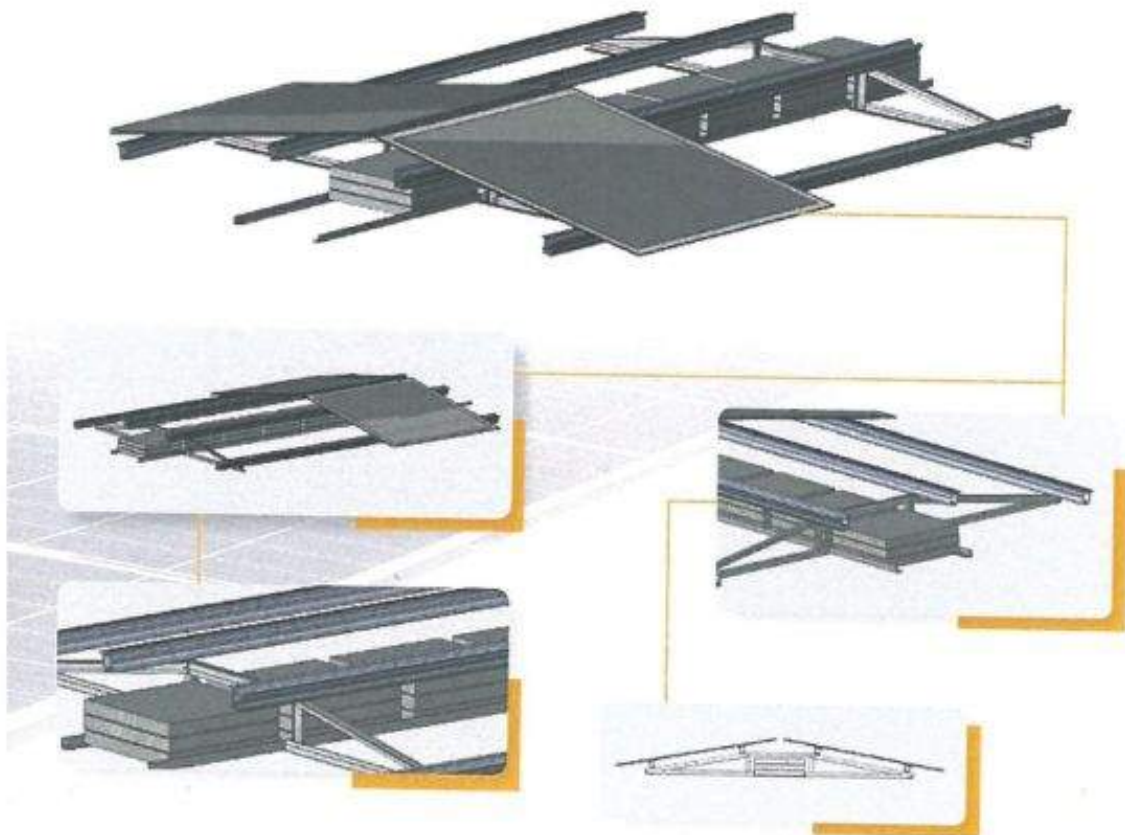

picture 1



picture 2



M-FR-360P

South system with ballasts



Table 1

Ballast per panel for 15° inclination
(assumed that the panel weights 15kg)

Wind speed (m/s)	Weight (kg)
25.3	139
28.3	177.5
30	204

Table 2

Span for 15° inclination using
2+2=4 cement blocks (Fig A)

Wind speed (m/s)	Span(m)
25.3	1.45
28.3	1.15

MOUNTING SYSTEMS FOR TILED ROOFS

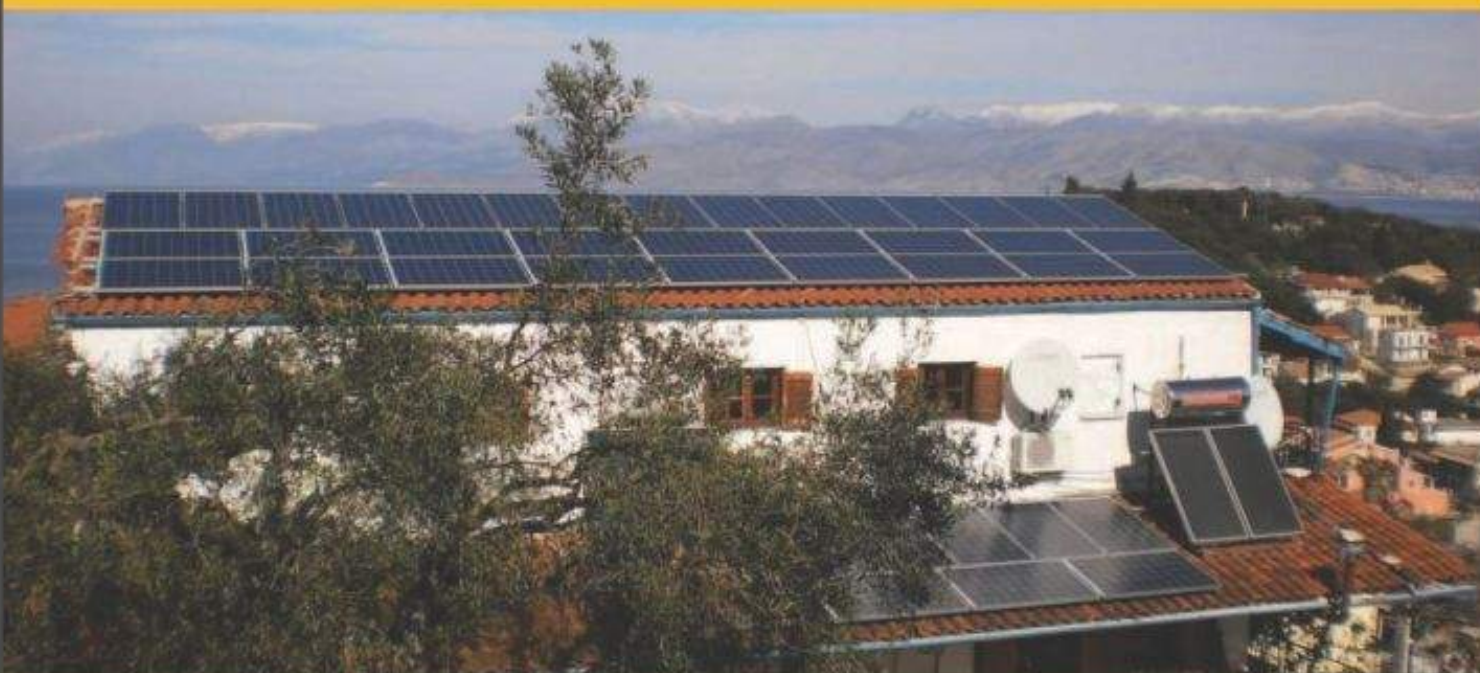

The innovative mounting systems for photovoltaic installations have been designed, developed and produced by METALOUMIN S.A. and apply to tiled roof installations.



MOUNTING SYSTEM WITH ALUMINIUM RAIL SL07 FOR TILED ROOF

In two different mounting types

- Hook (fixed **M-TR-400-1** or adjustable **M-TR-400-2**)
- Hanger Bolt (M10x200 **M-TR-600-M10**, M10x250 **M-TR-600-M10**, M12x300 **M-TR-600-M12**)

Advantages of the system :

- Easy and quick assembly
- No maintenance required
- Vertical in house production beginning with aluminium as raw material and resulting in final ready-to-be-installed product
- Unbeatable combination of robustness and price
- Production process certified with EN ISO 9001, TÜV CERT Austria and EN ISO 14001 standards
- High quality INOX Accessories

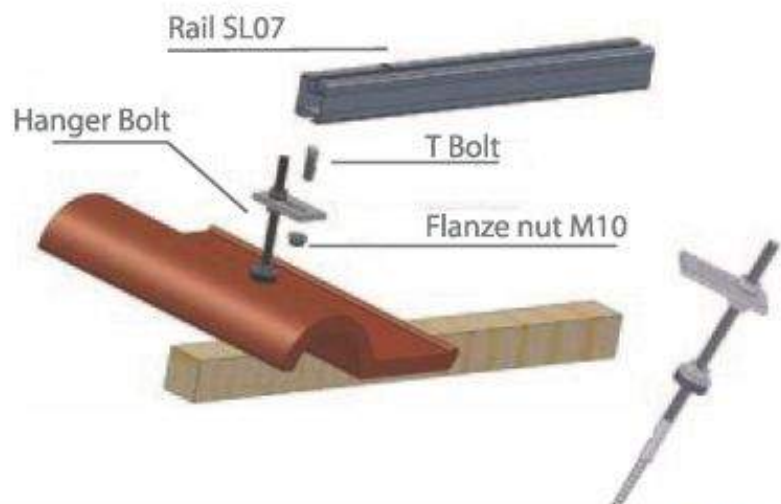
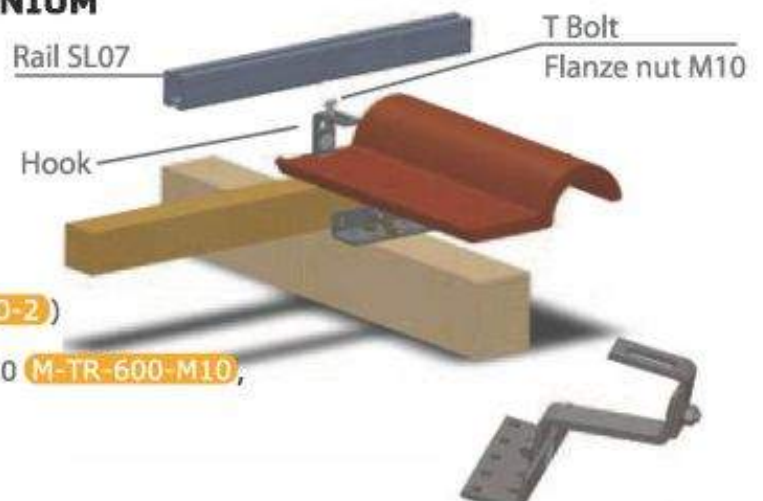

APPLICATION OF THE SYSTEM

M-TR-400

STEPS FOR THE APPLICATION OF THE HOOK

- Removal of the tile
- Installation of the hook with wood-screws 6mm x 60mm
- Cutting of the tile
- Re-installation of the tile

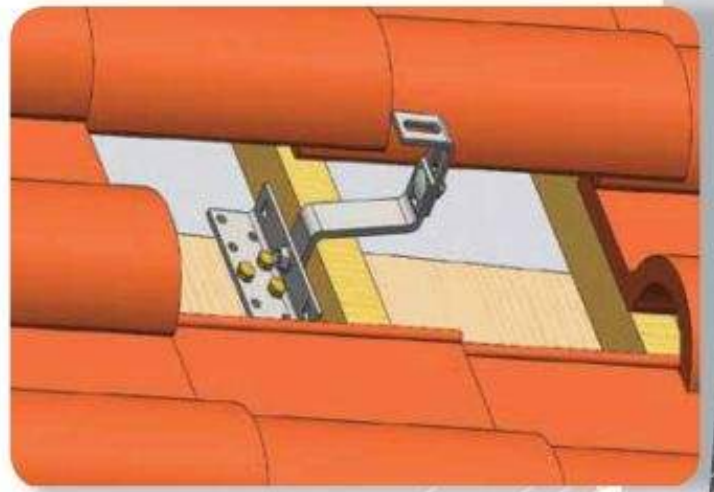

M-TR-600

STEPS FOR THE APPLICATION OF THE HANGER BOLT

- Drilling a hole $\Phi 13$ with diamond drill on the top of the tile
- Pre-drilling of a hole $\Phi 7$ on the wood (minimum dimension of the supporting wood beam 4 cm X 5 cm)
- Placing insulating material (acrylic or other) on the tile hole and hold the EPDM ring of the hanger bolt to seal the hole of the tile



SPECIFICATIONS FOR THE MOUNTING OF THE SYSTEM

Maximum bending moment:
0.70 KNm

Suggested distance between
supporting points:
1 – 1,6m



Maximum fastening torque
M10 T-Bolt: 30Nm
M8 BOLT CLAMP: 13Nm



INDUSTRIAL ROOF

MOUNTING STRUCTURES



Installation for industrial roofs
with accessibility from
the upper part of the roof

**The Integrated System
for Professional Solutions**

Metal seam roof

M-IR-800P-71

Clamp for metal seam roof with portrait layout

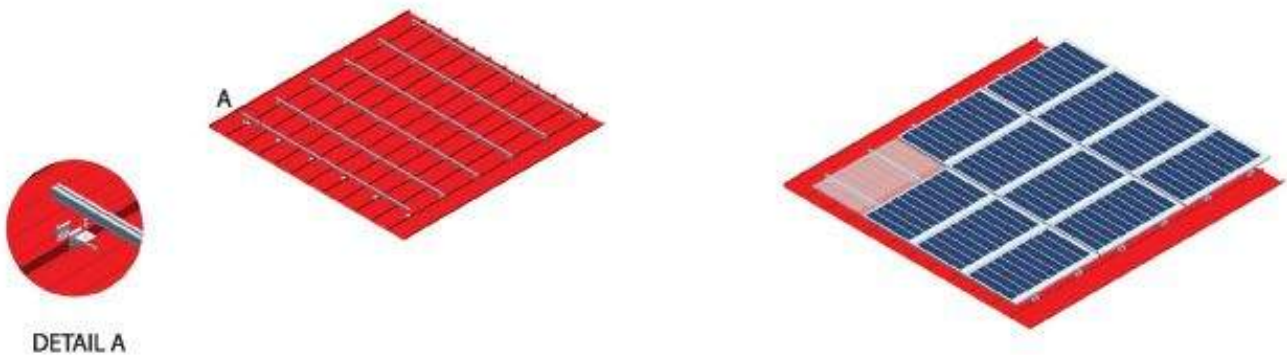

M-IR-800L-71

Clamp for metal seam roof with landscape layout

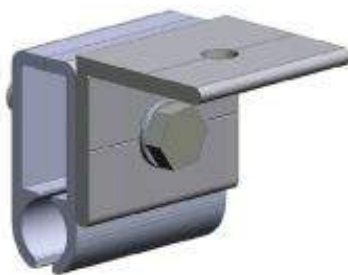
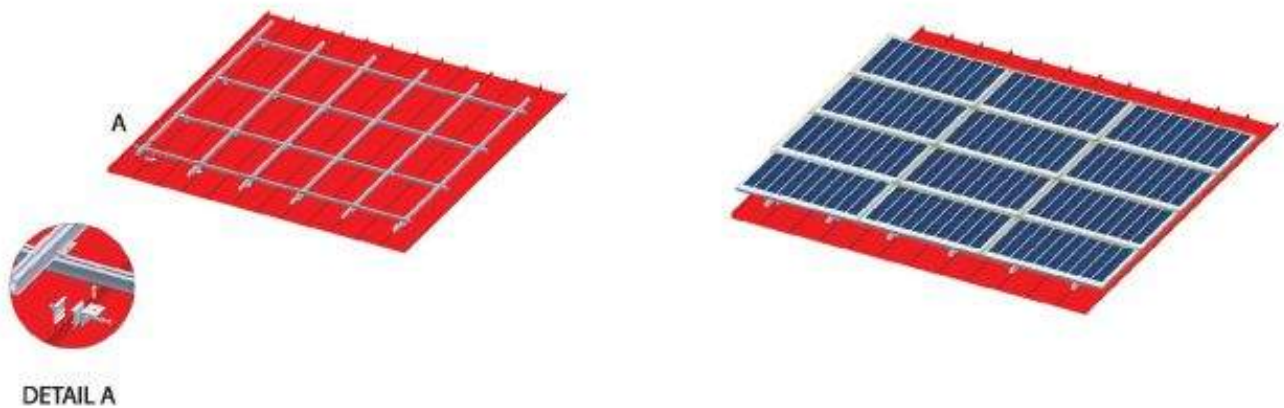

Clamp for metal seam roof

Mounting system specifications

- Mbmax for rail : 0.70 KNm (SL07)
- Anchoring using clamp for metal seam roof – aluminium product
- Portrait or Landscape orientation: Anchoring span ~ 0.8m
- Accessories : aluminum clamp, allen bolt M8 and square nut M8
- The square nut is placed in the channel of the pv rail (from up or the side) and then the clamp and the bolt are placed.
- Fastening torque 13Nm.

Trapezoidal polyurethane sandwich roof panel

M-IR-800L-64

Landscape orientation



M-IR-800P-64

Portrait orientation



Mounting system specifications

Mbmax for rail : 0.90 KNm (SL64)

Anchoring through self drilling screws:

Landscape orientation: anchoring by a pair of self – drilling screws per 0.5m

Portrait Orientation : secondary rail anchored by 2 pairs of self – drilling screws on the panel per 1– 1,1m. The main rail anchored by pair of self – drilling screws on the node.

Plain metal sheet roof top – corrugated or flat **M-IR-810**



Mounting system specifications

Mbmax for rail : 0.70 KNm (SL07)

Anchoring using threaded hanger bolts (fastener type BZ) fastened to the roof's steel frame

Portrait or Landscape orientation: Hanger bolts per 1– 1,1m

Plain metal sheet / sandwich panel roof top - corrugated or flat

M-IR-850



Mounting system specifications
Mbmax for rail: 0.7KNm (SL07)

Accessory SL65 - omega

Anchoring using self drilling screws (galvanized) on purlins

**Portrait or landscape orientation:
omega per 1-1.5m**

Pitched roof orientation-inclination change

M-IR-381L



Change orientation to south

Increase inclination

Turn to positive, a negative inclination

**Combination of pitched roof system
with flat roof system**

SINGLE POLE MOUNTING SYSTEMS FOR FIELD PV INSTALLATIONS WITH FIXED OR ADJUSTABLE INCLINATION



Metaloumin S.A. presents the fixed or adjustable inclination support structure of photovoltaic panels made of aluminum alloy AlSiMg 6063, which ensures extremely high strength and corrosion resistance. Given that the structure is consisted of expandable units, it is ready to cover all kinds of projects



SINGLE POLE ARRAY MOUNTING SYSTEM FOR FIELD PV PROJECTS WITH FIXED OR ADJUSTABLE INCLINATION

Technical details:

- The mounting system is designed, studied and certified in accordance with Eurocodes 1 and 9 (wind speed up to 33m/s).
- The necessary accessories (screws, nuts and bolts) used are of stainless steel.
- Easy and fast assembly of mounting system (only bolted connections).
- All joints are using bolts and nuts (friction joints class 3 according Euro code).
- Ability to overcome the thermal expansions through special patents.
- Insulation material between aluminum in order to avoid galvanic corrosion (INOX or Anodization).
- Diagonal cross bars to protect the assembly from side (E-W) wind load vibration.
- Adjustable to each project's needs
- Value for money
- No maintenance required

M-FA-100

SINGLE POLE SYSTEM WITH FIXED INCLINATION



For framed modules of dimension up to 1.700 mm. & non framed

M-FA-110

SINGLE POLE SYSTEM WITH ADJUSTABLE INCLINATION 15° - 25° - 35°

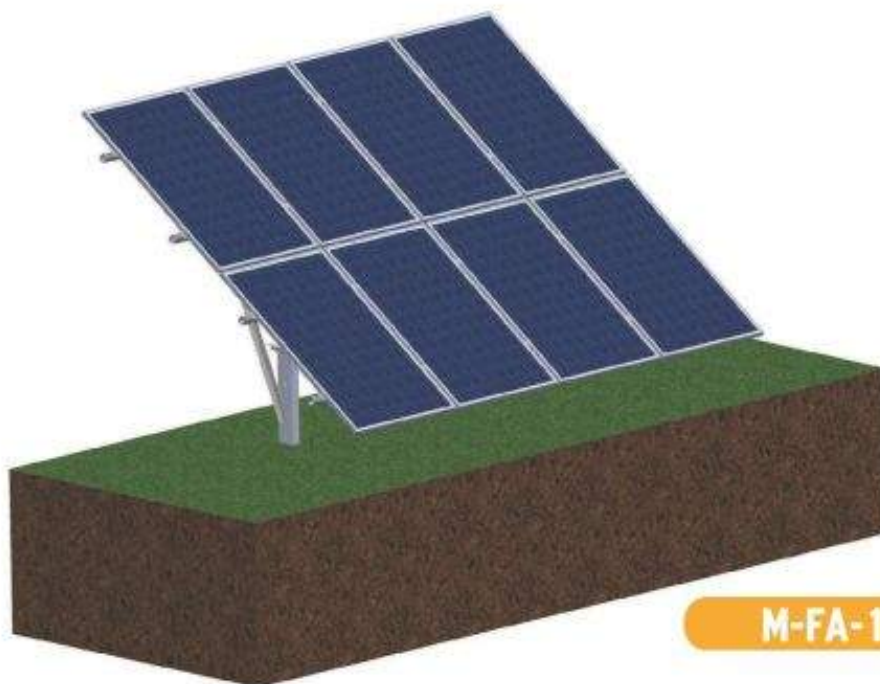

For framed modules of dimension
up to 1.700 mm. & non framed

TECHNICAL DATA

- 40-45m structures easy to assembly. Allowable spam up to 3,2m.
- Capability of supporting further PV equipment (such as inverters) on the body of the structure.
- The inclination of the mounting system is fixed (25°/30°) or adjustable (15°-25°-35° or to customers requirments).
- Ability of on-site adjustment of 5cm in height, 3cm in the N-S direction with the ability to turn 8° on the same time.

FOUNDATION

Ready for installation on pole that minimizes installation time.



The height of the pole depends on the ground resistance (typical length 2,85 m).



M-FA-100

Single pole system with fixed inclination



M-FA-110

Single pole system with adjustable inclination

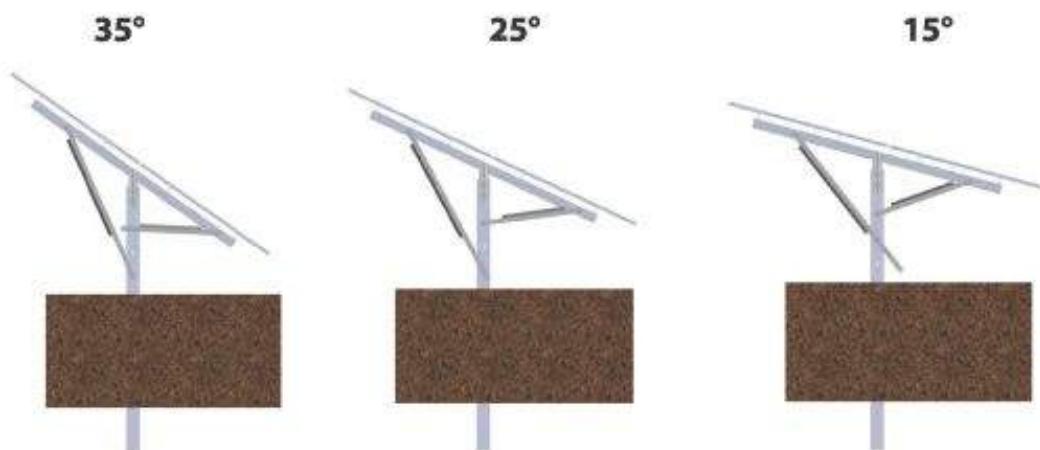

**TRIANGLE - SINGLE POLE
FIXED INCLINATION**

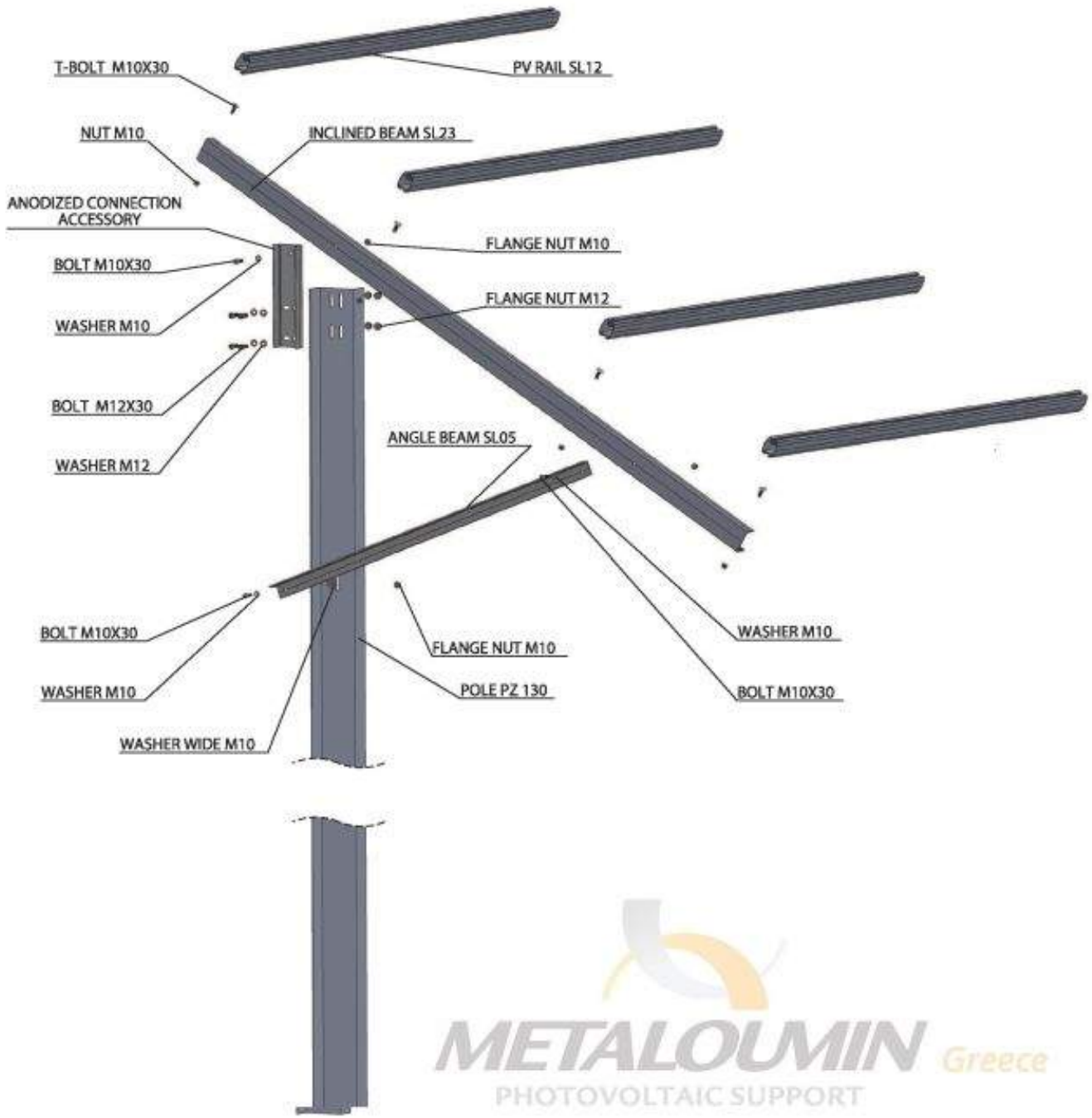

METALOUMIN *Greece*
 PHOTOVOLTAIC SUPPORT

M-FA-100



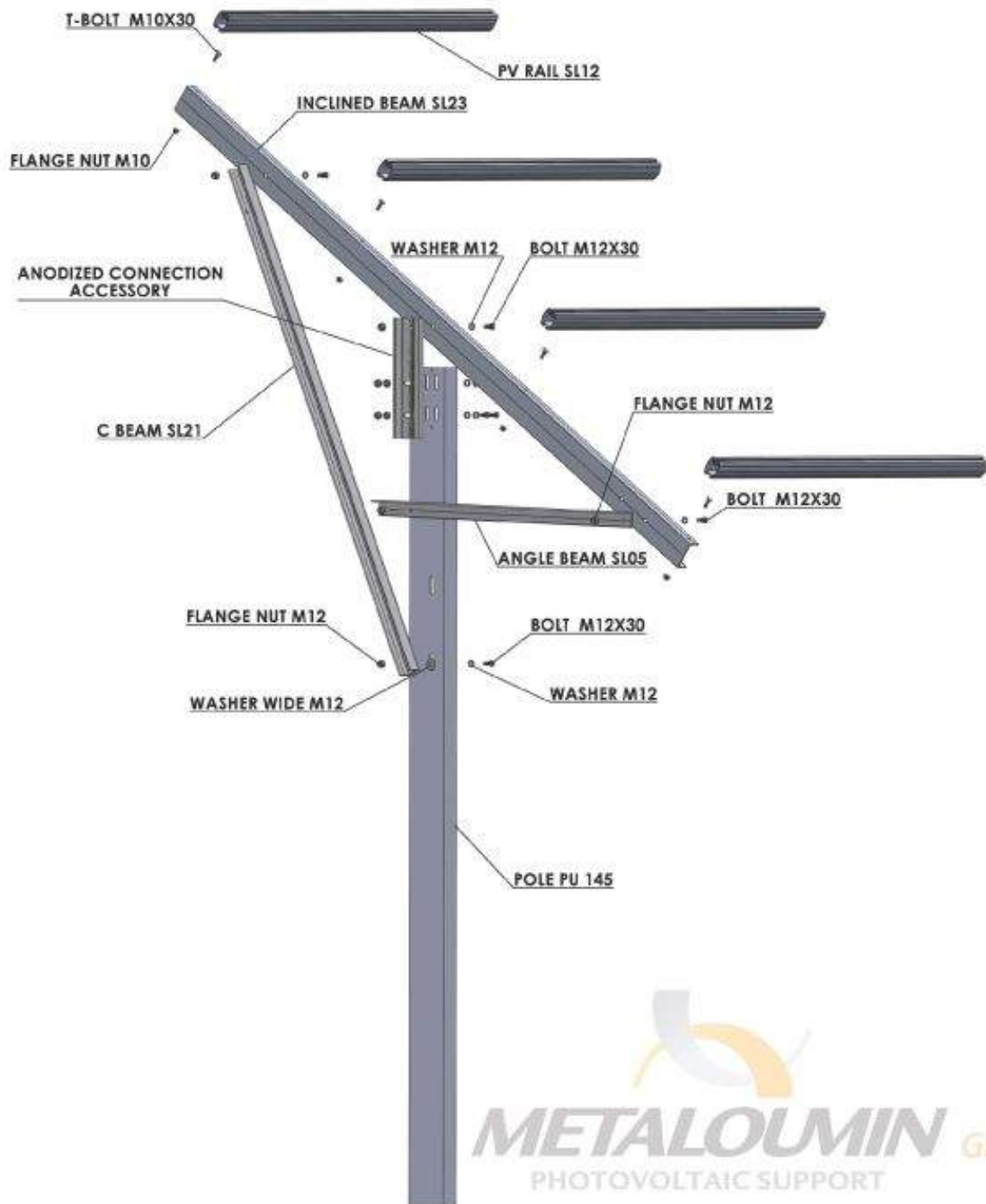









TRIANGLE - SINGLE POLE
ADJUSTABLE INCLINATION

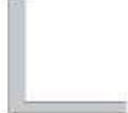

METALOUMIN *Greece*
PHOTOVOLTAIC SUPPORT

M-FA-110

MATERIAL TRIANGLE PARTS - SINGLE POLE SYSTEM

Num	MATERIAL	ILLUSTRATION	DESCRIPTION
1	SL12		PV Rail SL12
2	SL23		Inclined Beam
3	Aluminum accessory		Anodized connection accessory 35cm for fixed & 45cm for adjustable
4	SL05		Angle Beam SL05
5	SL21		C Beam for adjustable
6	SL350		Antiseismic angle 35x30
7	T-bolt INOX		T-bolt M10x30
8	DIN 933 INOX		bolt M10x30/M12x30
9	DIN 6923 INOX		Flanged nut M10/M12
10	DIN 125 INOX		Inox washer M10/M12
11	DIN 9021 INOX		Inox washer M10/M12
12	PZ-130		Pile for fixed
13	PU-145		Pile for adjustable

Special single pole mounting systems to customer's needs

M-FA-102L

DOUBLE LANDSCAPE

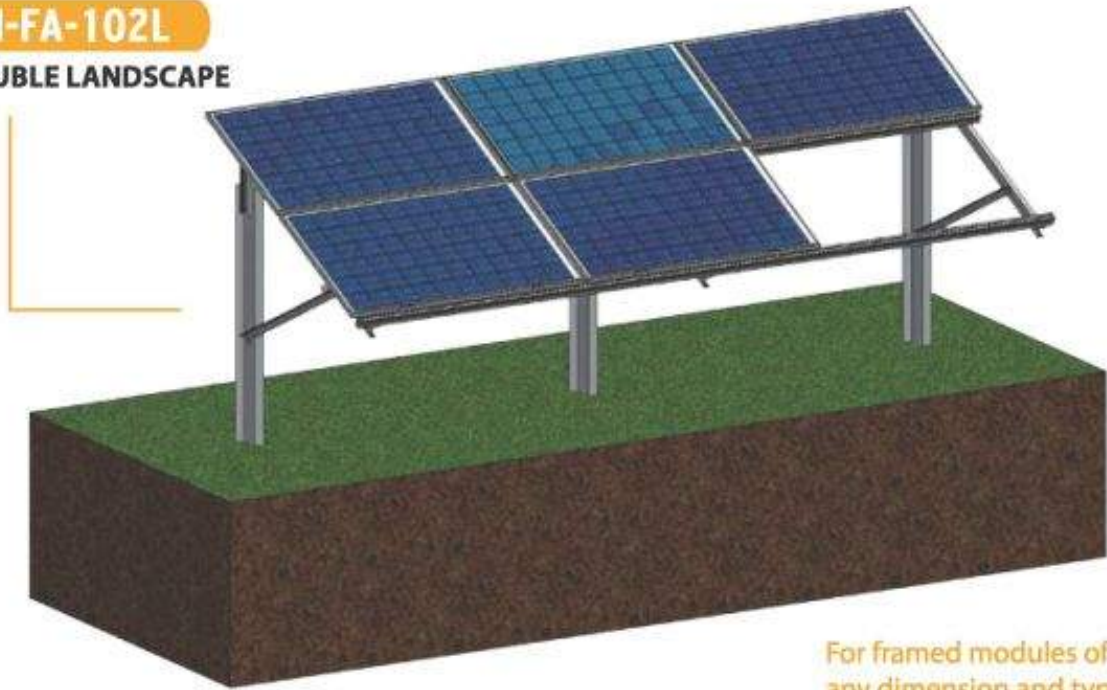

For framed modules of any dimension and type

M-FA-103L

TRIPLE LANDSCAPE



For framed modules of any dimension and type

NEW ERGONOMIC DOUBLE-POLE PV MOUNTING STRUCTURE FIELD APPLICATIONS



Metaloumin S.A. presents the fixed inclination support structure of photovoltaic panels made of aluminum alloy AlSiMg 6063, which ensures extremely high strength and corrosion resistance. Given that the structure is consisted of expandable units, it is ready to cover all kinds of projects.

METALOUMIN *Greece*
PHOTOVOLTAIC SUPPORT

2-P Panel Layout (Double PORTRAIT)

M-FA-202P



Technical Data:

- Capability of unlimited extension table length, due to thermal expansion neutralization
- Capability to accommodate further PV equipment on the body of structure
- System's flexibility and adaptability to any type of ground and slope.
- Guarantee of construction's longevity due to the highly resistant aluminum alloy.

TRIANGLE - DOUBLE POLE
2PANELS PORTRAIT

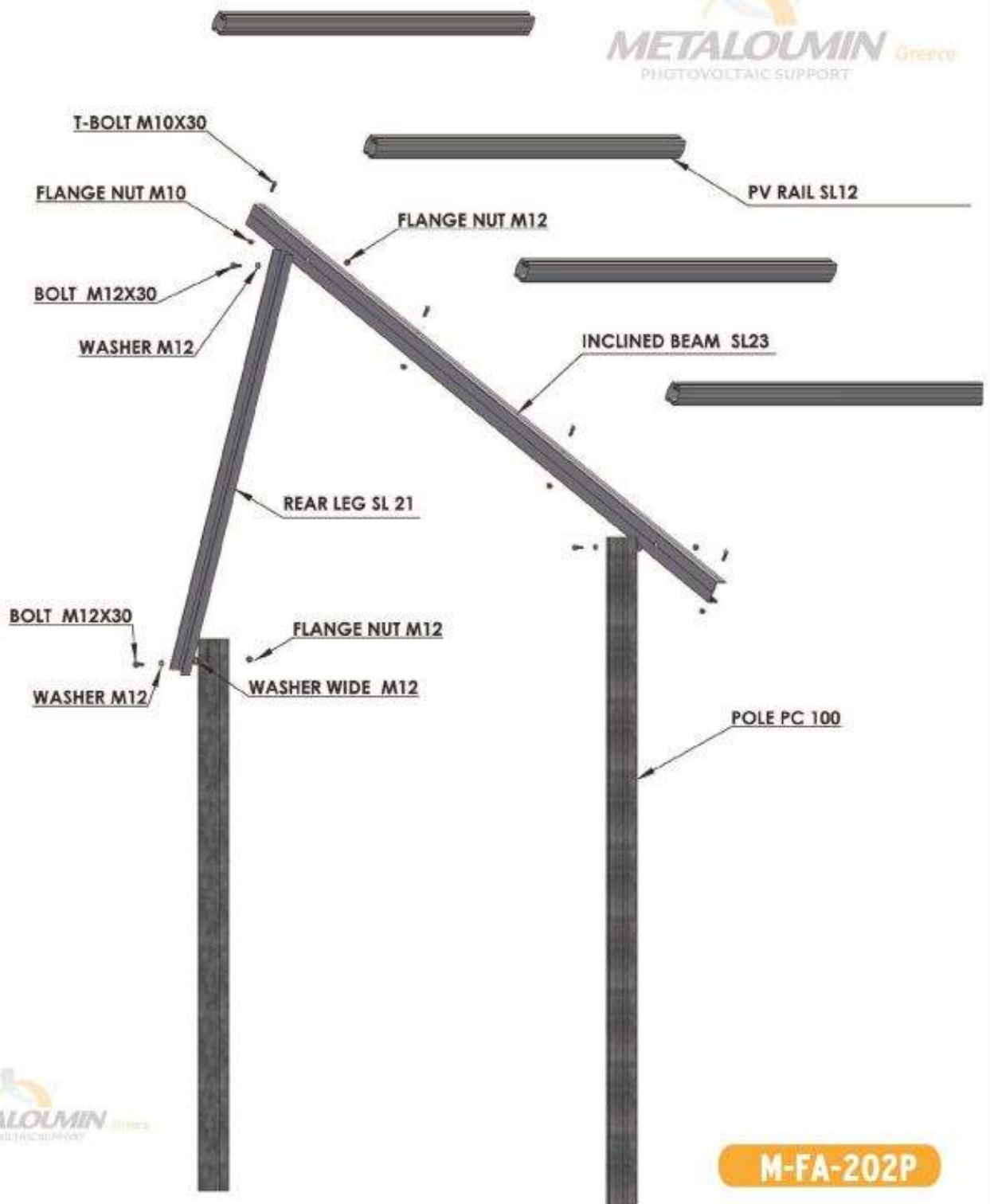

M-FA-202P

3-P Panel layout (Triple PORTRAIT)

M-FA-203P

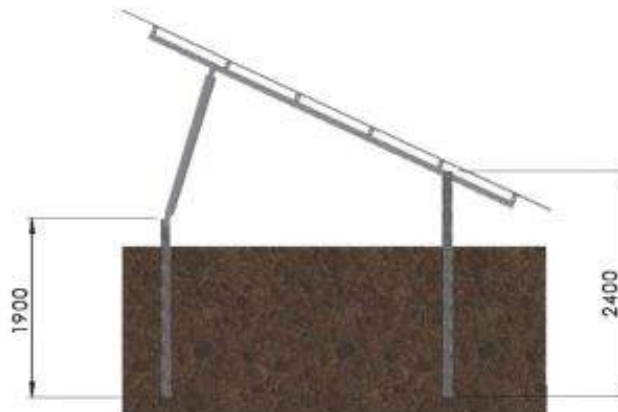

Advantages of the new double-pole system

- The double-pole system, installed, comes to the same cost as the single-pole system.
- The new system can be used on soft grounds instead of concrete foundation.
- Smaller number of bolted connections.
- Faster installation due to clever design and adjustability.
- The double-pole system is the best solution for areas with heavy load combinations due to wind, snow and earthquake.

TRIANGLE - DOUBLE POLE



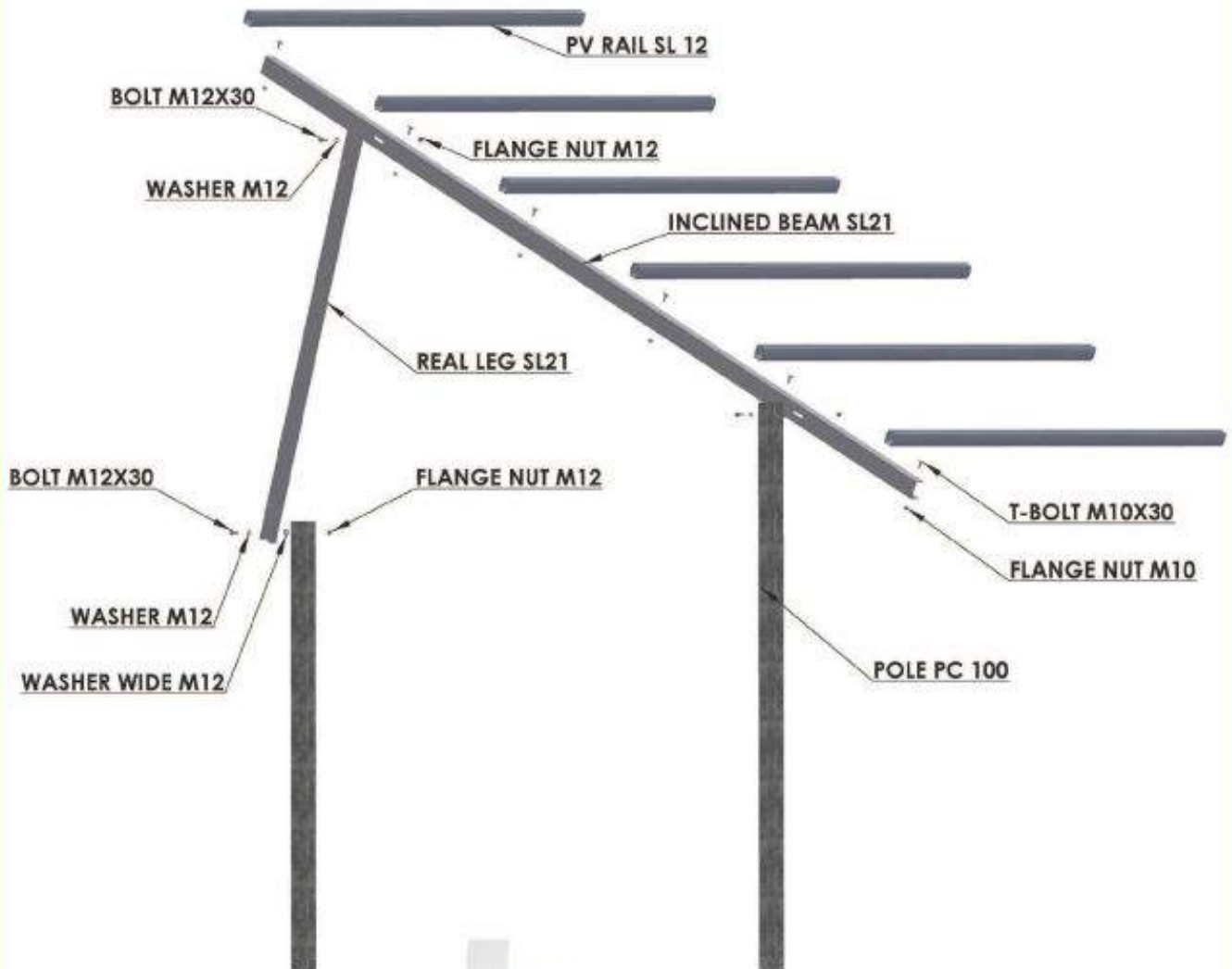







3PANELS PORTRAIT



METALOUMIN Greece
PHOTOVOLTAIC SUPPORT

M-FA-203P

MATERIAL TRIANGLE PARTS - DOUBLE POLE SYSTEM

Num	MATERIAL	ILLUSTRATION	DESCRIPTION
1	SL12		PV Rail SL12
2	SL23		Inclined Beam
3	SL21		Rear Leg
4	SL350		Antiseismic angle 35x30
5	T-bolt INOX		T-bolt M10x30
6	DIN 933 INOX		Bolt M10x30/M12x30
7	DIN 6923 INOX		Flanged nut M10/M12
8	DIN 125 INOX		Inox washer M10/M12
9	DIN 9021 INOX		Wide Washer M10/M12
10	PC-100		Pile

Advantages of METALOUMIN systems



- Adjustable to the needs of each project
- Fast Installation with easy to mount technical equipment and accessories
- Value for money
- Certified static study
- Availability of stock due to streamlined production at our Extrusion Plant
- Reliable and environmentally friendly products

METALOUMIN systems:

Fixed Support Structures of
Photovoltaic Systems for Installation for:

**Field Units – Flat Roofs
Tiled Roofs - Industrial Roofs**

- Fast Bolted Assemblies
- Aluminium Alloy AlSiMg606355
- Statically Certified by Eurocodes 1 & 9



PATENTED

TÜV
AUSTRIA

TÜV
AUSTRIA
HELLAS



EN ISO 14001:2004
No. 2483157



METALOUMIN *Greece*
PHOTOVOLTAIC SUPPORT

20 St. Fanouriou str., 13678, Acharnes, Athens, Greece

Tel.: +30 210 2463630, Fax: +30 210 2464471

international@metaloumin.gr, www.metaloumin.gr

3-4-2017